

# Slotpanel

---



Slotpanel is a cost effective and space efficient form of merchandising that transforms displayed products. As a back drop, it creates a lasting, stylish impression, bringing out the maximum potential of products.

Slotpanel is a popular versatile display system, consisting of unlimited horizontal grooves, which accommodate a large variety of fittings that conveniently slide into the slot.

# Slotpanel

---



## Verstility / Durability / Choice / Quality

Slotpanel is a cost effective and space efficient form of merchandising that transforms displayed products. As a back drop, it creates a lasting, stylish impression, bringing out the maximum potential of products.

Slotpanel is a popular versatile display system, consisting of unlimited horizon grooves, which accommodate a large variety of fittings that conveniently slide into the slot.

From corporate offices to retail shops, Slotpanel can be used in most work environments. Its durability ensures a long lasting finish, no matter how many times displays are changed.

Slotpanel is manufactured in Australia, using premium grade 18mm MDF for maximum strength. It is machined by CNC routers which ensure a consistently accurate high quality finish.

Choose from the updated colour palette of selected popular colours, prints and woodgrains. Alternatively, Slotpanel can be supplied in a raw, ready to paint form.

# Slotpanel

---



BALSA



OAK TREE



VICTORIA



STRAIGHT  
BEECH



GOLD BEECH



SMOOTH  
MAPLE



SILKY  
BEECH



CRAB APPLE



NOBLE  
CHERRY



JARRAH



WALNUT

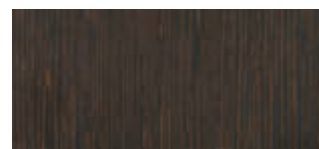

WENGE



BRUSHED  
ALUMINIUM



PEPPERPOT



SEAL  
GREY



BLACK



BRONZE

# Slatboard

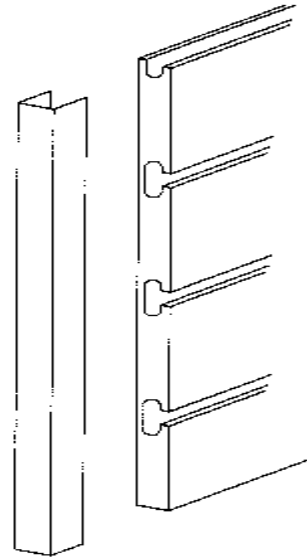
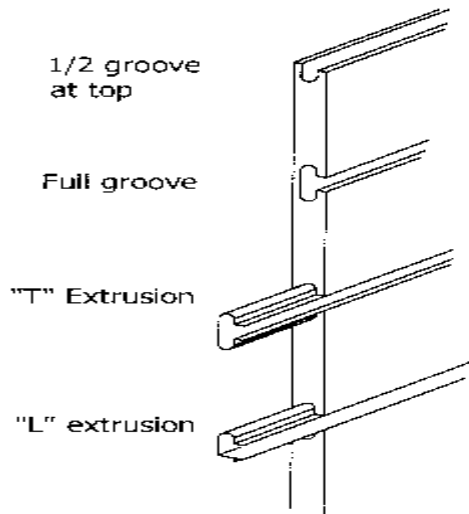

Slatboards available in either landscape or portrait as shown below.  
Standard groove spacing is 100mm centre to centre with a 1/2 groove at the top of the Landscape panel which is designed to conceal the joint behind the extrusion when one sheet is installed on top of another.

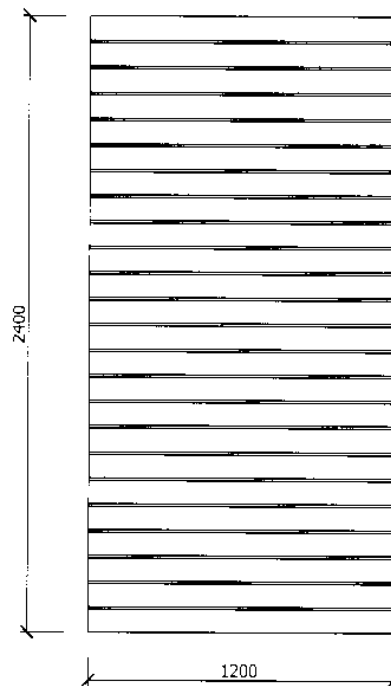
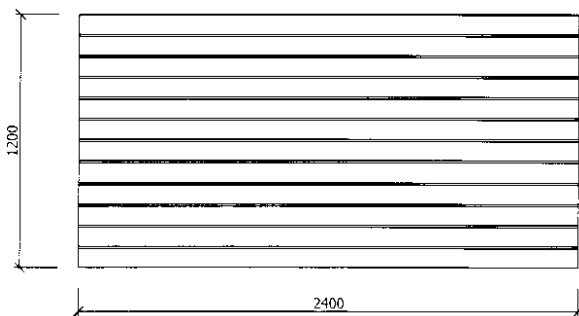

# Slatboard

---

## Square White Melamine

EGSQW  
1000mm L x 1000mmW x 1310mmH

Includes castors

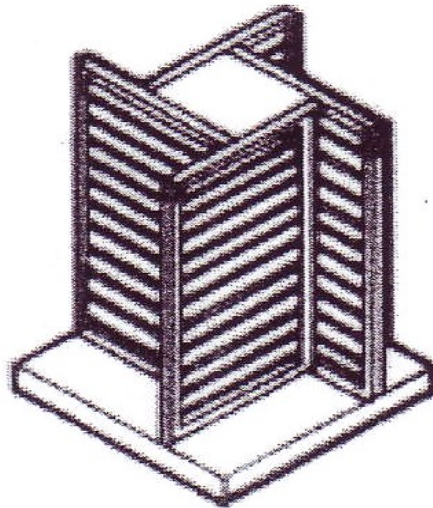

## Rectangular White Melamine

EGREW  
1600mm L x 1000mm W x 1310mmH

Includes castors

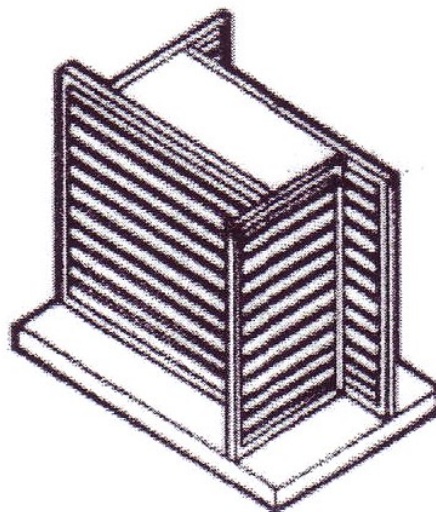

# Slatboard

---

## **Budget**

470	1200mmL x 620mm W x 1310mm H	\$1075.00 inc GST
2225	1800MML x 620mm W x 1310mm H	\$1385.00 inc GST

**NB - All units include castors**

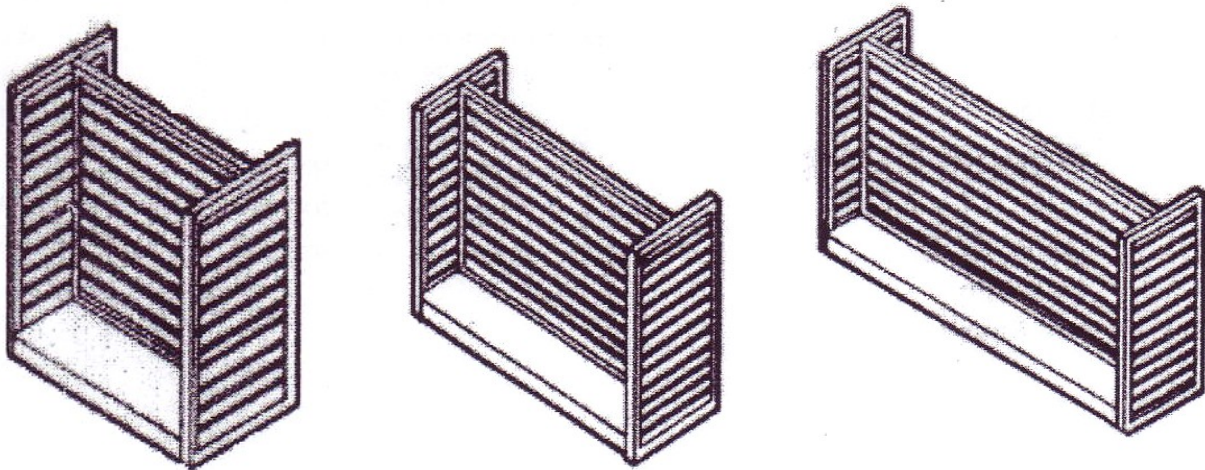

# Slatboard



**SLOTPLANK TOP/BOTTOM PANEL**  
 2400MM X 400MM HIGH, 18MM THICK WITH 3  
 ALUMINIUM INSERTS

**CODE S3705WEAL**  
**COLOUR WENGE**

**CODE S3705WHAL**  
**COLOUR WHITE**

**CODE S3705BKAL**  
**COLOUR BLACK,**

**CODE S3705BHAL**  
**COLOUR BEECH**



**SLOTPLANK CENTRE PANEL**  
 2400MM X 400MM HIGH, 18MM THICK WITH 3 ALUMINIUM INSERTS

**CODE S3700WEAL**  
**COLOUR WENGE**

**CODE S3700WHAL**  
**COLOUR WHITE**

**CODE S3700BKAL**  
**COLOUR BLACK**

**CODE S3700BHAL**  
**COLOUR BEECH**

# Slatboard

---



SLOTWALL INSERTS  
2400MM LONG  
**CODE S3613AL**  
**COLOUR ALUMINIUM**



ANODISED EDGING CHANNEL 2500MM FOR PANELS  
18MM THICK  
**CODE S3605AL**  
**COLOUR ALUMINIUM**



SLOTWALL FREESTANDING  
PANEL  
1200MM X 600MM HIGH  
**CODE M8400WH**  
**COLOUR WHITE**

# Slotwall – Gondolas

---

NEW



CHROME FRAMED SLOTWALL  
GONDOLA WHITE  
**CODE:** M8300WHCH  
**SIZE:** 1250X632X1270MM

NEW



CHROME FRAMED SLOTWALL  
GONDOLA BEECH  
**CODE:** M8300BHCH  
**SIZE:** 1250X632X1270MM

NEW



CHROME FRAMED SLOTWALL  
GONGOLA BLACK  
**CODE:** M8300BKCH  
**SIZE:** 1250X632X1270MM