

Joining rails

Joining rail

51 H × 25.4 mm D.
Use turn-lock tool to assist with installation.
Turn-lock tool can be found on page 30.

600 mm bay
E2106.4

WTS White sand

BKS Black sand

CH Chrome

Quantity	Saving	Each inc GST
1-9	–	\$21.00
10-49	8%	\$19.25
50+	16%	\$17.50

Reward pricing Each inc GST

G \$17.50 **S** \$19.25

Quantity	Saving	Each inc GST
1-9	–	\$26.00
10-49	7%	\$24.00
50+	15%	\$22.00

Reward pricing Each inc GST

G \$22.00 **S** \$24.00

900 mm bay
E2109.4

WTS White sand

BKS Black sand

CH Chrome

Quantity	Saving	Each inc GST
1-9	–	\$25.00
10-49	6%	\$23.50
50+	13%	\$22.00

Reward pricing Each inc GST

G \$22.00 **S** \$23.50

Quantity	Saving	Each inc GST
1-9	–	\$30.00
10-49	6%	\$28.00
50+	13%	\$26.00

Reward pricing Each inc GST

G \$26.00 **S** \$28.00

1200 mm bay
E2112.4

WTS White sand

BKS Black sand

CH Chrome

Quantity	Saving	Each inc GST
1-9	–	\$28.00
10-49	8%	\$25.50
50+	17%	\$23.00

Reward pricing Each inc GST

G \$23.00 **S** \$25.50

Quantity	Saving	Each inc GST
1-9	–	\$35.00
10-49	5%	\$33.00
50+	11%	\$31.00

Reward pricing Each inc GST

G \$31.00 **S** \$31.90

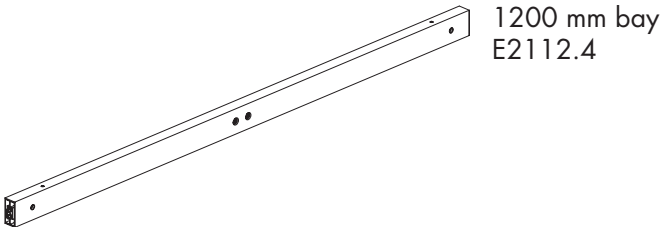
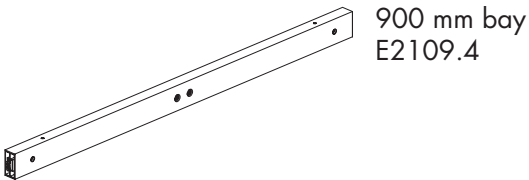
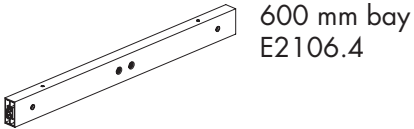

Joining rails

Base joining rail

120 H x 25.4 mm D.
Use turn-lock tool to assist with installation.
Turn-lock tool can be found on page 30.

600 mm bay E2606.4

WTS White sand

BKS Black sand

CH Chrome

Quantity	Saving	Each inc GST
1-9	-	\$36.00
10-49	8%	\$33.00
50+	16%	\$30.00

Reward pricing Each inc GST

G \$30.00 **S** \$33.00

Quantity	Saving	Each inc GST
1-9	-	\$44.00
10-49	8%	\$40.50
50+	17%	\$37.00

Reward pricing Each inc GST

G \$37.00 **S** \$40.50

900 mm bay E2609.4

WTS White sand

BKS Black sand

CH Chrome

Quantity	Saving	Each inc GST
1-9	-	\$44.00
10-49	7%	\$40.50
50+	15%	\$37.00

Reward pricing Each inc GST

G \$37.00 **S** \$40.50

Quantity	Saving	Each inc GST
1-9	-	\$50.00
10-49	6%	\$47.00
50+	12%	\$44.00

Reward pricing Each inc GST

G \$44.00 **S** \$47.00

1200 mm bay E2612.4

WTS White sand

BKS Black sand

CH Chrome

Quantity	Saving	Each inc GST
1-9	-	\$47.00
10-49	7%	\$43.50
50+	14%	\$40.00

Reward pricing Each inc GST

G \$40.00 **S** \$43.50

Quantity	Saving	Each inc GST
1-9	-	\$58.00
10-49	6%	\$54.50
50+	12%	\$51.00

Reward pricing Each inc GST

G \$51.00 **S** \$54.50

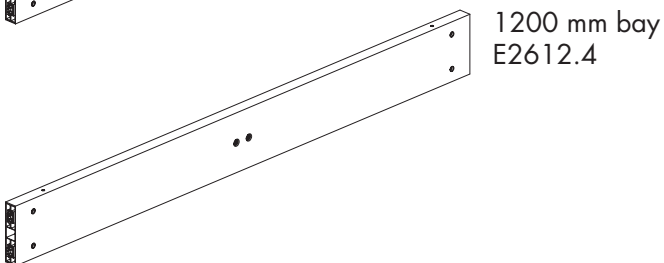
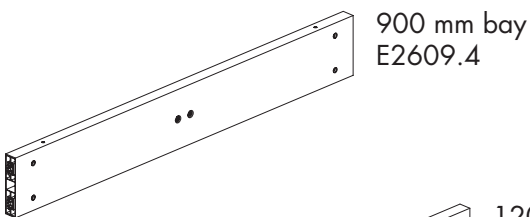
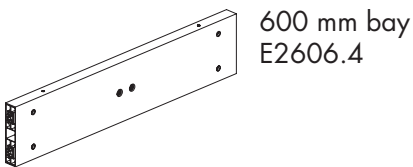

Feet, heels & castors

Foot

25.4 W × 120 mm H.
 M10 thread at base of feet.
 200 mm feet not suitable on posts taller than 1480 mm.
 Use turn-lock tool & soft faced mallet to assist with installation.
 Turn-lock tool & soft faced mallet can be found on page 30.
 Allows for optional castors.
 Castors to only be used on posts strengthened with brace plates.

200 mm E2002.4

WTS White sand

BKS Black sand

Quantity	Saving	Each inc GST
1-9	–	\$18.45
10-49	9%	\$16.70
50+	18%	\$14.95

Reward pricing Each inc GST

G \$14.95 **S** \$16.70

CH Chrome

Quantity	Saving	Each inc GST
1-9	–	\$22.95
10-49	6%	\$21.45
50+	13%	\$19.95

Reward pricing Each inc GST

G \$19.95 **S** \$21.45

300 mm E2003.4

WTS White sand

BKS Black sand

Quantity	Saving	Each inc GST
1-9	–	\$20.45
10-49	9%	\$18.45
50+	19%	\$16.45

Reward pricing Each inc GST

G \$16.45 **S** \$18.45

CH Chrome

Quantity	Saving	Each inc GST
1-9	–	\$24.95
10-49	8%	\$22.95
50+	16%	\$20.95

Reward pricing Each inc GST

G \$20.95 **S** \$22.95

400 mm E2004.4

WTS White sand

BKS Black sand

Quantity	Saving	Each inc GST
1-9	–	\$21.45
10-49	9%	\$19.45
50+	18%	\$17.45

Reward pricing Each inc GST

G \$17.45 **S** \$19.45

CH Chrome

Quantity	Saving	Each inc GST
1-9	–	\$26.95
10-49	7%	\$24.95
50+	14%	\$22.95

Reward pricing Each inc GST

G \$22.95 **S** \$24.95

500 mm E2005.4

WTS White sand

BKS Black sand

Quantity	Saving	Each inc GST
1-9	–	\$23.95
10-49	10%	\$21.45
50+	20%	\$18.95

Reward pricing Each inc GST

G \$18.95 **S** \$21.45

CH Chrome

Quantity	Saving	Each inc GST
1-9	–	\$30.95
10-49	6%	\$28.95
50+	12%	\$26.95

Reward pricing Each inc GST

G \$26.95 **S** \$28.95

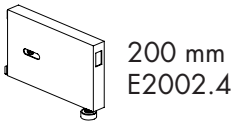

200 mm
E2002.4

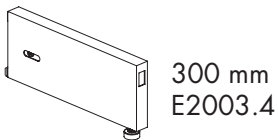

300 mm
E2003.4

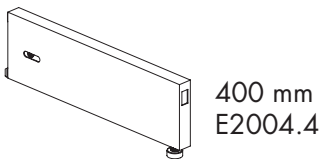

400 mm
E2004.4

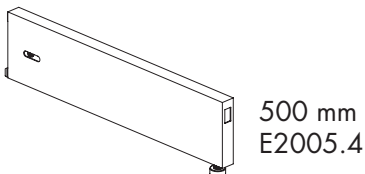

500 mm
E2005.4

Feet, heels & castors

Heel

E2000.4

25.4 W x 25.4 D x 120 mm H.
M10 thread at base of heel.
For single sided freestanding displays use heel on the back of the double sided post.

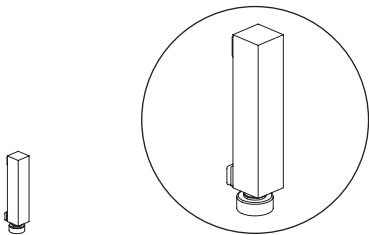

WTS White sand

BKS Black sand

Quantity	Saving	Each inc GST
1-9	-	\$7.95
10-49	10%	\$7.15
50+	21%	\$6.30

Reward pricing Each inc GST

G \$6.30 **S** \$7.15

CH Chrome

1-9	-	\$10.25
10-49	10%	\$9.20
50+	20%	\$8.15

Reward pricing Each inc GST

G \$8.15 **S** \$9.20

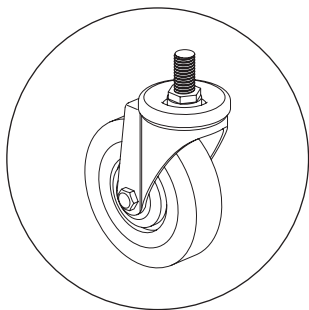

Castor

E1070.4

75 DIA x 21 W x 100 mm H.
M10 mounting bolt.
Bracing plates must be used when using castors.
Bracing plates can be found on page 21.

CH Chrome

1-4	-	\$8.95
5-19	17%	\$7.45
20+	34%	\$5.95

Reward pricing Each inc GST

G \$5.95 **S** \$7.45

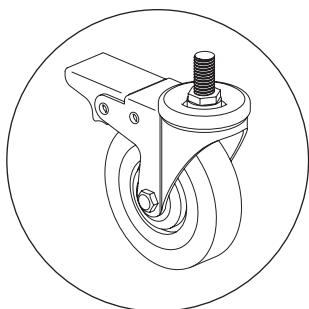

Castor with brake

E1071.4

75 DIA x 21 W x 100 mm H.
M10 mounting bolt.
Bracing plates must be used when using castors.
Bracing plates can be found on page 21.

CH Chrome

1-4	-	\$9.95
5-19	15%	\$8.45
20+	30%	\$6.95

Reward pricing Each inc GST

G \$6.95 **S** \$8.45

Flat feet

Single sided flat feet used on freestanding display against a wall

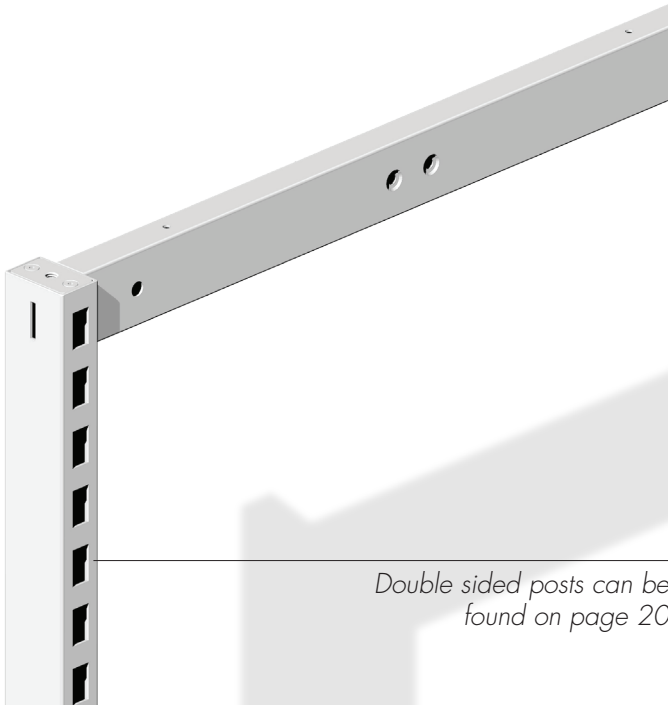

Double sided posts can be found on page 20

Double sided flat feet used on freestanding mid floor display

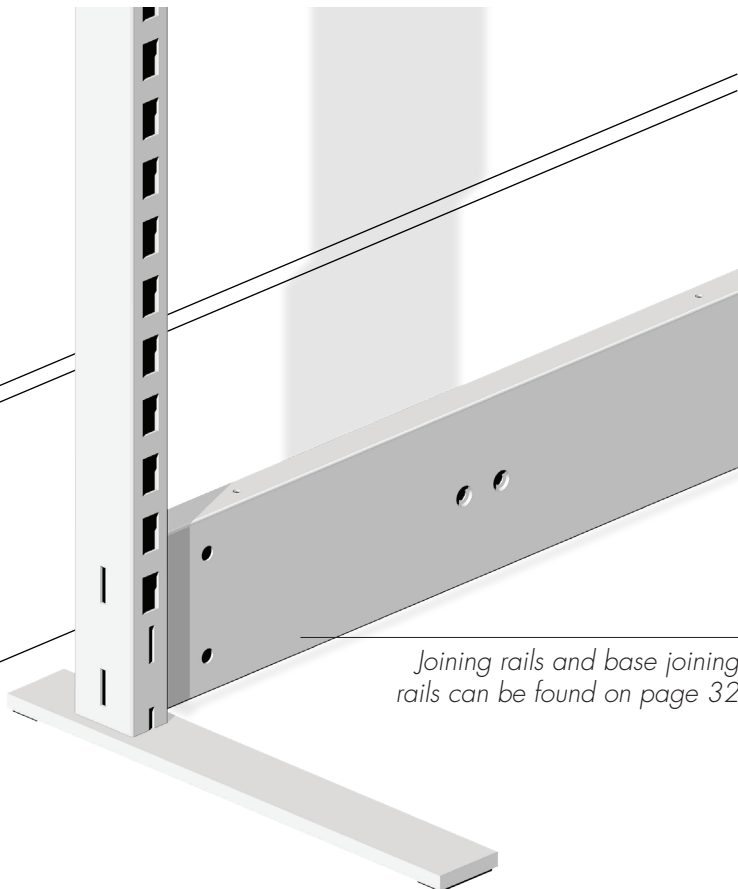

Joining rails and base joining rails can be found on page 32

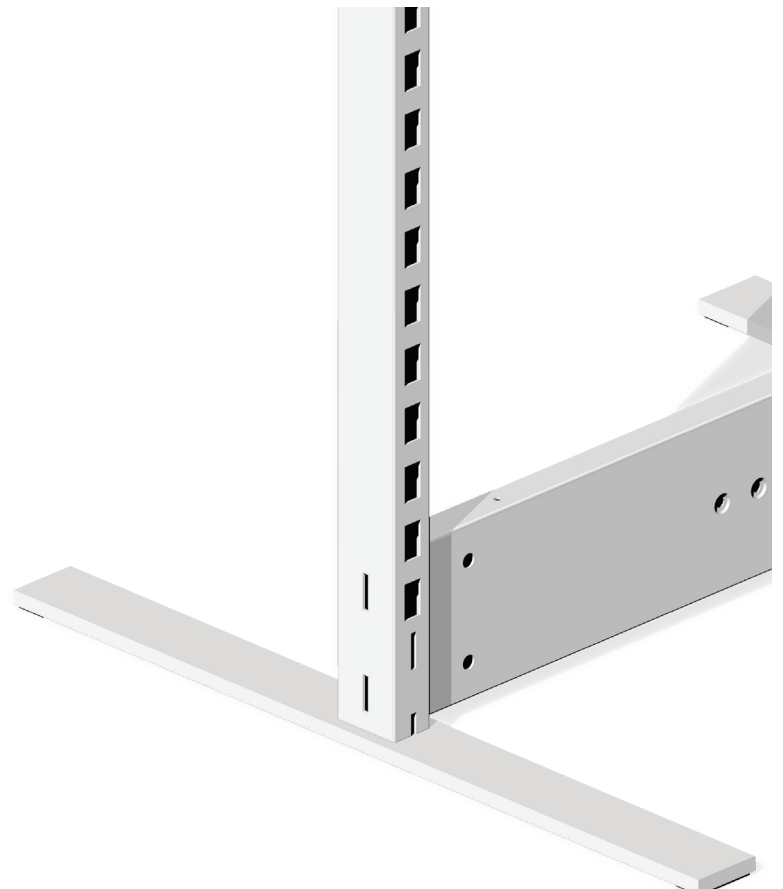

Flat feet

Double sided post flat foot

Single sided flat foot:
100 W x 375 D x 8 mm Thick.

Double sided flat foot:
100 W x 600 D x 8 mm Thick.

Flat foot not suitable on posts taller than 1800 mm.

Single sided E2301.4

 WTS White sand

 BKS Black sand

Quantity	Saving	Each inc GST
1-9	-	\$13.95
10-49	11%	\$12.35
50+	22%	\$10.75

Reward pricing Each inc GST

 \$10.75  \$12.35

Double sided E2302.4

 WTS White sand

 BKS Black sand

1-9	-	\$19.95
10-49	8%	\$18.45
50+	15%	\$16.95

Reward pricing Each inc GST

 \$16.95  \$18.45

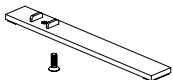

Single sided
E2301.4

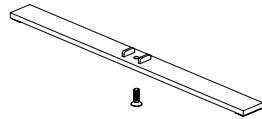

Double sided
E2302.4